

P200 - wall mounted

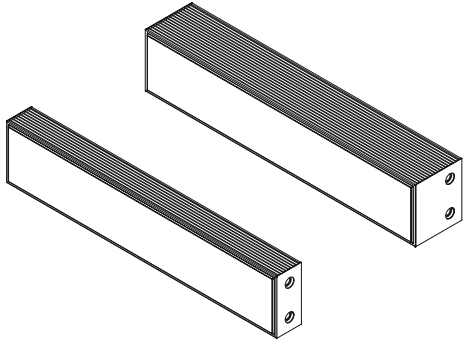

P200, depths 98 and 178 mm

P200 - floor mounted

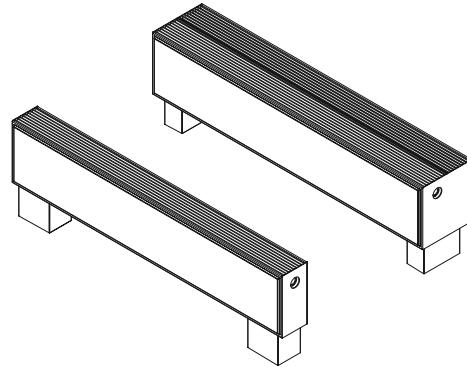

P200, depths 105 and 198 mm

P200 - wall and floor mounted

Height and length

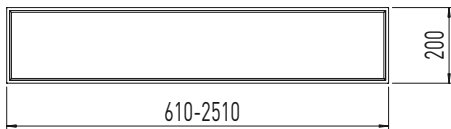

P200/98

P200/178

P200/105

P200/198

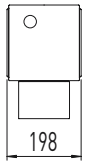
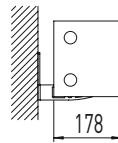
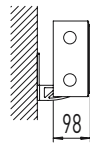

P200 - with built-in valve

P200/98, wall mounted, built-in valve format 1, tappings E-F/F-E

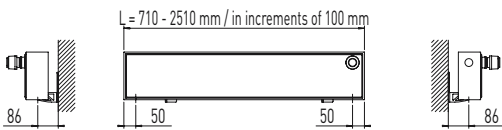

P200/105, floor mounted, built-in valve format 1, tappings E-F/F-E

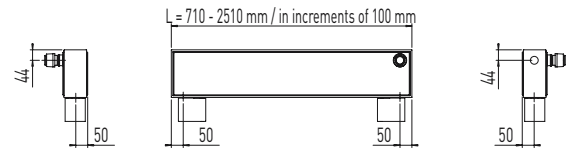

P200/98, wall mounted, built-in valve format 3, tappings E-F/F-E

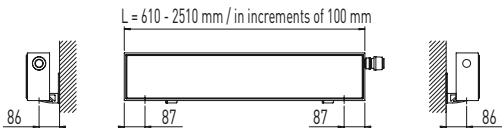

P200/105, floor mounted, built-in valve format 3, tappings E-F/F-E

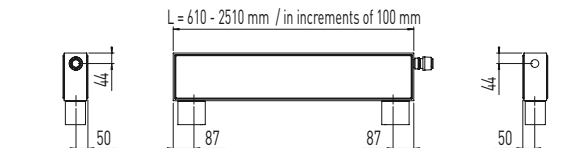

Length 610-2510 mm, in increments of 100 mm

Height 200 mm

Depth Wall mounted: 98 and 178 mm
Floor mounted: 105 and 198 mm

Tappings 1/2" inside thread or 3/4" outside thread, adapter for 3/4" outside thread

Mounting Wall or floor mounted
Wall brackets are included
Option: Prepared for feet
Air vent is included
P200 for floor mounting is supplied with Plan back plate

Colour Powder coated in white RAL 9010
Top grille: Natural anodised aluminium
Options:
Radiator: Coated in other standard RAL and BS colours
Top grille: Same colour as radiator

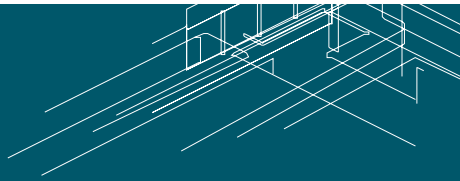

Output - wall mounted

P200 Model	Output		Water content litres/metre	Weight kg/metre
	W/metre 75°/65°/20°	W/metre 90°/70°/20°		
P200/98	599	752	1.8	19.4
P200/178	1006	1265	2.7	29.0

Output - floor mounted

P200 Model	Output		Water content litres/metre	Weight kg/metre
	W/metre 75°/65°/20°	W/metre 90°/70°/20°		
P200/105	599	752	1.8	22.5
P200/198	1006	1265	2.7	33.2

Build-in dimensions - wall mounted

P200/98 and 178. Tappings A-B-C-D



P200/98 and 178. Tappings E-F/F-E



P200/98 and 178. Tappings 2E/2F and 2F/2E



Tapping options for P200/98 and 178

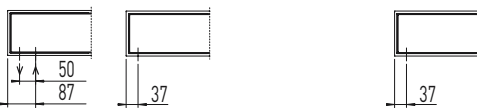

Build-in dimensions - floor mounted

P200/105 and 198. Tappings A-B-C-D



P200/105 and 198. Tappings E-F/F-E



P200/105 and 198. Tappings 2E/2F and 2F/2E



Tapping options for P200/105 and 198

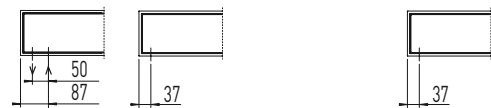

Tapping designation - wall and floor mounted

Tapping designation A-B-C-D and E-F, front view

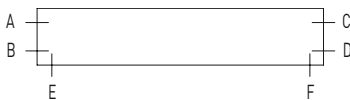

Tapping designation 2E/2F, front view

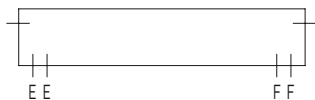

Accessories - wall and floor mounted

Adjustable LK feet

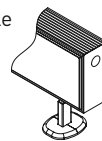

Bracket LK for P200/98

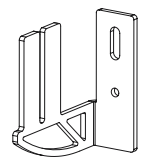

FDC feet

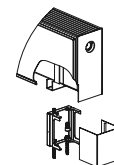

Bracket LK for P200/178

